

# **DIMENSIONS UNLIMITED, INC.**

4467 White Bear Pkwy. (651) 653-7000  
St. Paul, MN 55110-7626 Fax (651) 653-7600  
www.dimensionsunlimited.com  
email: sales@dimensionsunlimited.com

Form: 121954D  
April 2006

---

---

ISO 9001:2000 Registered Company

## **Dimensions Unlimited, Inc.**

### **DC to AC Standby Power Systems**

Owners Manual for Models:

**12X16B3R4T**

**12X20B3R4T**

**12X25B3R4T**

**12X30B3R4T**

**12X36B3R4T**

**Including Options:**

**R1:** LCD Remote Control/Status Panel  
with master disconnect

# Table of Contents:



<b>Section</b>	<b>Description</b>	<b>Page</b>
<b>1</b>	<b>Safety Instructions</b> .....	<b>3</b>
1.1	Warning and Danger Symbols .....	3
1.2	Standby Power System Precautions .....	3
1.3	Battery Precautions .....	3
<b>2</b>	<b>Specifications</b> .....	<b>4</b>
<b>3</b>	<b>Technical description</b> .....	<b>5</b>
3.1	Standby Power Systems .....	5
3.1.1	Inverter Power Mode .....	5
3.1.2	External Power Mode .....	5
3.2	Features .....	6
3.2.1	Battery Charger – “B3” .....	6
3.2.2	LCD Remote Control/Status Panel – “R4” .....	6
3.2.3	Transfer Switch – “T” .....	6
3.3	Options .....	6
3.3.1	LCD Remote Control/status Panel – “R1” Option .....	6
<b>4</b>	<b>SPS Physical Description</b> .....	<b>7</b>
4.1	SPS Module .....	7
4.2	LCD Remote Control/Status Panel .....	8
<b>5</b>	<b>Installation</b> .....	<b>9</b>
5.1	Tools Needed for Installation .....	9
5.2	System Components .....	9
5.3	Mounting the SPS .....	9
5.3.1	Chassis Bonding Lug .....	9
5.3.2	Temperature Compensation Sense Probe .....	9
5.3.3	Connecting the LCD Remote Control/Status Panel .....	9
<b>6</b>	<b>SPS Wiring</b> .....	<b>11</b>
6.1	DC Wiring .....	11
6.1.1	Inverter Cable .....	11
6.1.2	Charge Cable .....	11
6.1.3	Connecting the DC Wires .....	12
6.1.4	Deep Cycle Batteries .....	12
6.2	AC Wiring .....	13
6.2.1	AC Output .....	13
6.2.2	AC Input .....	13
6.3	DC Wiring Diagram .....	14
6.4	AC Wiring Diagram .....	15
<b>7</b>	<b>Operation and Troubleshooting</b> .....	<b>16</b>
7.1	Operation .....	16
7.1.1	Setting the Battery Size and Type .....	16
7.1.2	Turning the SPS On .....	16
7.1.3	Battery Charger Draw – Set Input .....	17
7.1.4	LCD Remote Control/Status Panel Display Messages .....	17
7.2	Troubleshooting .....	19
7.2.1	Troubleshooting Chart .....	19
7.2.2	System Flow Chart .....	21
<b>8</b>	<b>Warranty</b> .....	<b>23</b>

# Safety Instructions

**Important:** Read this manual before installation, it contains important safety, installation, and operating instructions. Save this manual and keep it in a safe place.

## 1.1 Warning and Danger Symbols:

To reduce the risk of electrical shock and to ensure the safe operation of your Dimensions power inverter, the following symbols are used throughout the manual.

<p><b>ATTENTION:</b></p>  <p>Important operating instructions. Follow them closely.</p>	<p><b>DANGER:</b></p>  <p>Risk of personal harm and/or electrocution exists in this area. Use extreme caution.</p>
<p><b>SAFETY CERTIFICATION:</b></p>  <p>This is a UL and CUL Certified product that complies with all the safety standards required in the USA and Canada for land vehicle inverters.</p>	

## 1.2 Standby Power System Precautions:

- Standby Power Systems produce hazardous voltages. To avoid risk of harm or fire, the unit must be properly installed.
- There are no user serviceable parts inside, do not remove the cover.
- The Standby Power Systems should not be mounted in a location that may be exposed to rain or spray.
- The Standby Power Systems should not be installed in a zero clearance enclosure.
- Damage to the Standby Power Systems will occur if correct polarity is not observed when installing the DC input cables.
- Damage to the Standby Power Systems will occur if an external AC power source is applied to the inverter's AC hardwire output.
- The Standby Power Systems contains a circuit breaker and capacitor that may produce a spark. Do not mount in a confined battery or gas compartment.
- Be sure the Standby Power Systems is turned OFF during installation.

## 1.3 Battery Precautions:

- Working in the vicinity of lead-acid batteries is dangerous. There is a risk of acid exposure.
- Batteries generate explosive gases during operation.
- There is risk of high current discharge from shorting a battery that can cause fire and explosion. Use insulated tools during installation.
- Remove all rings, watches, jewelry or other conductive items before working near the batteries.
- Inspect the batteries once a year for cracks, leaks or swelling.
- Dispose of the batteries according to local regulations. Do not incinerate batteries; risk of explosion exists.

# Specifications

## Millennium Series

### Standby Power Systems

**12X16B3R4T, 12X20B3R4T,  
12X25B3R4T, 12X30B3R4T,  
12X36B3R4T**

**Output Voltage (VAC)** 120 RMS  $\pm 5\%$   
**Output Frequency:** 60 Hz  $\pm 0.05\%$   
**Output Waveform:** Quasi-sine wave, with waveform stabilizer  
**Input Voltage: (VDC)** 11 to 14  
**Operating Temperature:** -20° to 40° C (0° to 104° F)  
**Efficiency:** Up to 93%

**Environmentally Friendly,  
Quiet, Reliable, AC Power**



**Enhanced**

#### Other Design Features:

- Thermally controlled cooling fan.
- Enclosed AC and DC cable connections with strain relief.
- Built-in battery charger "B3" and transfer relay "T"

#### Remote Control Panel – "R4":

- LCD Display – Blue background, 16 white characters by two lines with user-friendly messages.
- Dimensions – W x H x D: 5.75" x 3.75" x 1.25"
- Optional DC master disconnect switch control wire with assembly panel 141315-1 only

#### Unit Protection:

- Automatic electronic short circuit/overload protection
- Automatic high temperature shutdown
- Output circuit breakers

#### Battery Protection:

- Automatic low battery shutdown at 10.5 VDC (with in-rush delay)

MODEL NUMBER	12X16	12X20	12X25	12X30	12X36
<b>Output Power</b> (Watts Cont.)	1,600	2,000	2,500	3,000	3,600
<b>Output Current</b> (Amps AC)	Up to 13	Up to 17	Up to 21	Up to 25	Up to 30
<b>Peak Output</b> (Amps AC)	55	70	80	90	90
<b>Output Rating:</b> (hp)	1/3	1/2	3/4	1	1 1/2
<b>Input Current</b> (Amps DC)	Up to 160	Up to 200	Up to 250	Up to 300	Up to 360
<b>Weight</b> (lbs.)	40	44	49	53	58
<b>Dimensions</b> LxWxH (Inches)	15 3/4 x 11 1/2 x 7 3/4				
<b>BATTERY CHARGER "B3"</b>	3 step charger with automatic conditioning; Temperature compensated output voltage; selectable between wet and sealed lead acid batteries; selectable between small and large battery banks				
<b>Output Current</b> (Amps DC)	75	100	130	140	140
<b>Input Current</b> (Amps AC)	Up to 16	Up to 21	Up to 26	Up to 28	Up to 28
<b>TRANSFER RELAY "T"</b>	Fail-safe shore power Transfer Relay				
<b>Current Rating</b> (Amps AC)	30				
<b>Transfer Time</b> (milliseconds)	Less than 16 typical				

- **Usage:** Any 120 VAC, 60 Hz single-phase products within the standby power system's rating that does not require a pure sine waveform.

# Technical Description

## 3.1 Standby Power System:

A Standby Power System is a DC to AC power inverter with a battery charger "B3" and an automatic fast transfer switch "T".

**Note:** In this manual, we will use the acronym SPS when referring to a Standby Power System.

A remote LCD control/status panel controls the SPS and provides system status by displaying user-friendly screen messages.

The system has two operational modes: Inverter power mode and external power mode.

**3.1.1 Inverter Power Mode:** The SPS converts DC power from batteries to usable 120 VAC, 60 Hz power. The direct current (DC) that enters the SPS is filtered by a large input capacitor and switched "On" and "Off" by the Metal Oxide Silicon Field Effect Transistors (MOSFET) at a rate of 60 cycles per second, and directed into the transformer which steps the voltage up to 120 volts. The unit has a Digital System Processor (DSP) to control the output voltage and frequency as the DC input voltage and/or output load varies. The signal output waveform shape is not sinusoidal; it has a total harmonic distortion of 31% and a maximum single harmonic distortion of 25%.

**3.1.2 External Power Mode:** 120 VAC, 60 Hz external power can be applied directly to the SPS by hardwire connections to the AC input wire leads provided in the field-wiring compartment. When external power is present, the internal transfer switch cannot be defeated; it automatically turns the DC to AC inverter OFF and activates the three-step battery charger. At this time the loads attached to the SPS output will operate directly from the external power line even if the SPS was turned OFF manually. The internal transfer relay automatically switches the SPS back to "inverter power" mode in the absence of external power whenever the SPS was previously set to ON.

## **3.2 Features**

**3.2.1 Battery Charger – “B3” Option:** External power 120 VAC, 60 Hz is applied as explained in section 3.1.2 The internal transfer switch automatically turns the DC to AC inverter OFF and turns the three-step built-in battery charger ON. The battery charger cannot be defeated at this time and will engage even if the inverter has been set OFF manually. SPSs with the three-step battery charger feature require the transfer switch “T” option to operate.

The 3-steps of the charging process are as follows:

**Bulk mode:** Charging current is passed through the batteries until a factory set acceptance voltage limit is reached. The charger’s maximum output and/or the state of charge of the batteries determine the amount of current.

**Acceptance mode:** Charging continues with the voltage held at the accept voltage until current flow decreases to the factory set end value or the factory set acceptance mode time limit is reached.

**Float mode:** Battery voltage is held at a factory set value, which will neither charge nor discharge the batteries.

Condition mode occurs every 10<sup>th</sup> charge cycle between Acceptance mode and Float mode to ensure full restoration of active materials in all the plates of the battery cells.

The SPS has an automatic power sharing feature that automatically decreases the battery charger output so that the total AC input current draw by the SPS for both the AC loads and the battery charger does not exceed 30 amps AC. If the loads exceed 30 amps the charger will be at zero amp draw and the AC input circuit breaker will trip. The battery charger draw will automatically increase when the external loads are reduced if the batteries will accept more current.

**3.2.2 LCD Remote Control/Status Panel – “R4”:** The SPS can only be controlled by the remote control/status panel which is connected to the SPS module by a gray flat 8-conductor wire. There are three push buttons and a red LED that when lit indicates a trouble condition. The remote control/status panel provides system status through a 16-character by 2 line LCD display.

**3.2.3 Transfer Switch – “T” Option:** The transfer switch automatically switches between “Inverter mode” and “External power mode” depending of the external power line availability. External power 120 VAC, 60 Hz can be applied directly to the SPS AC input as explained in section 3.1.2.

## **3.3 Options**

**3.2.1 LCD Remote Control/Status Panel – “R1” Option:** This option is the same as “R4” except the LCD Remote Control/Status Panel – “R1” part number 141315-1 includes a 1-foot control wire extending from the back for DC master disconnect if available in the coach.

# SPS Physical Description

## 4.1 SPS Module

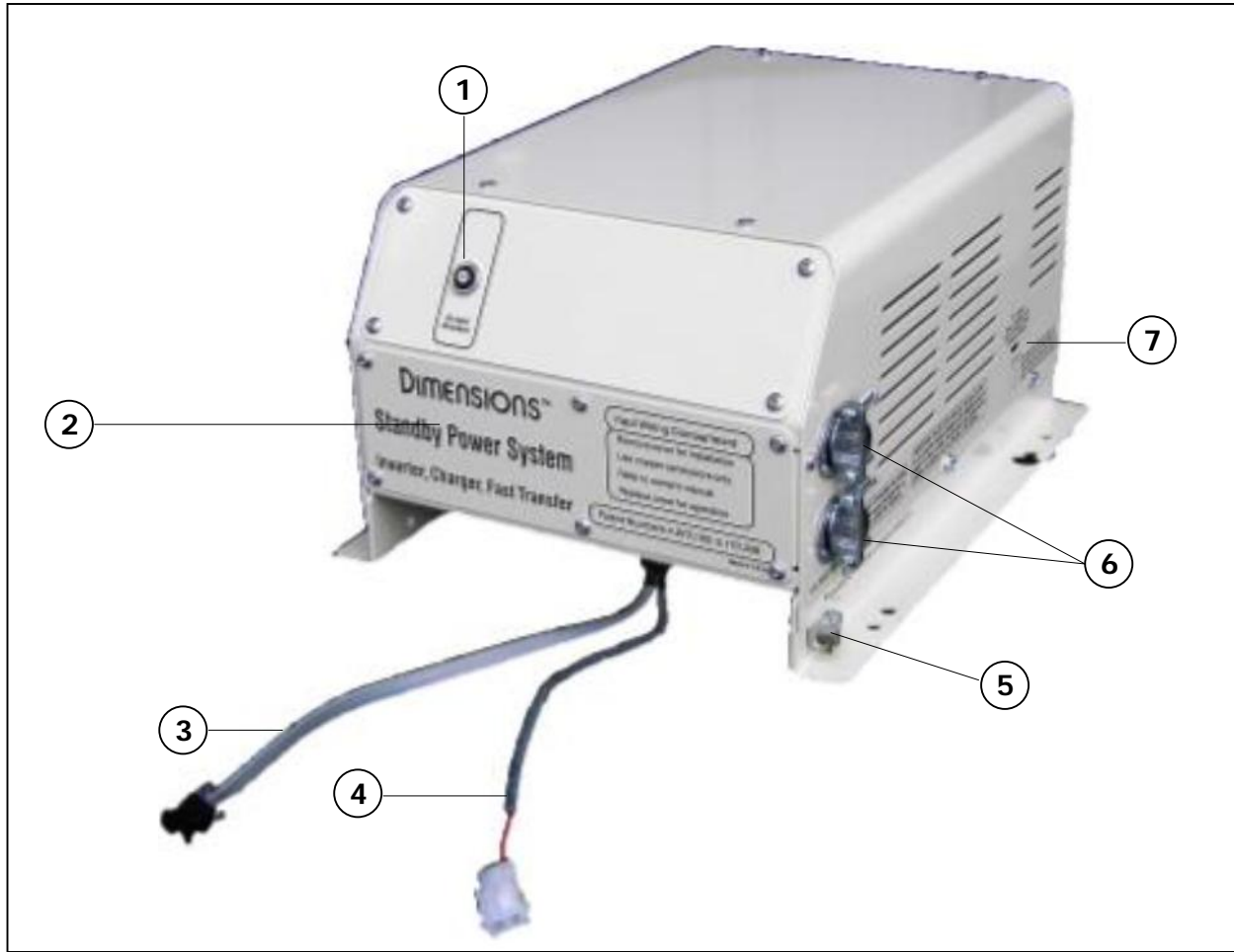

FIGURE 1: SPS physical description

Item #	Description	Function
1	Output Breaker – 30A	Trips to protect the SPS from hardwire AC output short circuit or overload.
2	Field Wiring Compartment Cover	Remove the faceplate to access the AC Input/Output lead wires and DC field-wiring compartment.
3	Remote Control Panel Connector	Connects to the LCD Remote Control/Status Panel
4	Temperature Compensation Sensor Connector	Connects to the remote temperature sense probe.
5	Bonding Lug	Connects to the ground system.
6	DC input entry opening	Allows the DC cables to reach the DC input terminal connector.
7	Battery Capacity Selector Switch	Sets the correct battery type and the capacity of the battery bank for proper charging.

## 4.2 LCD Remote Control/Status Panel

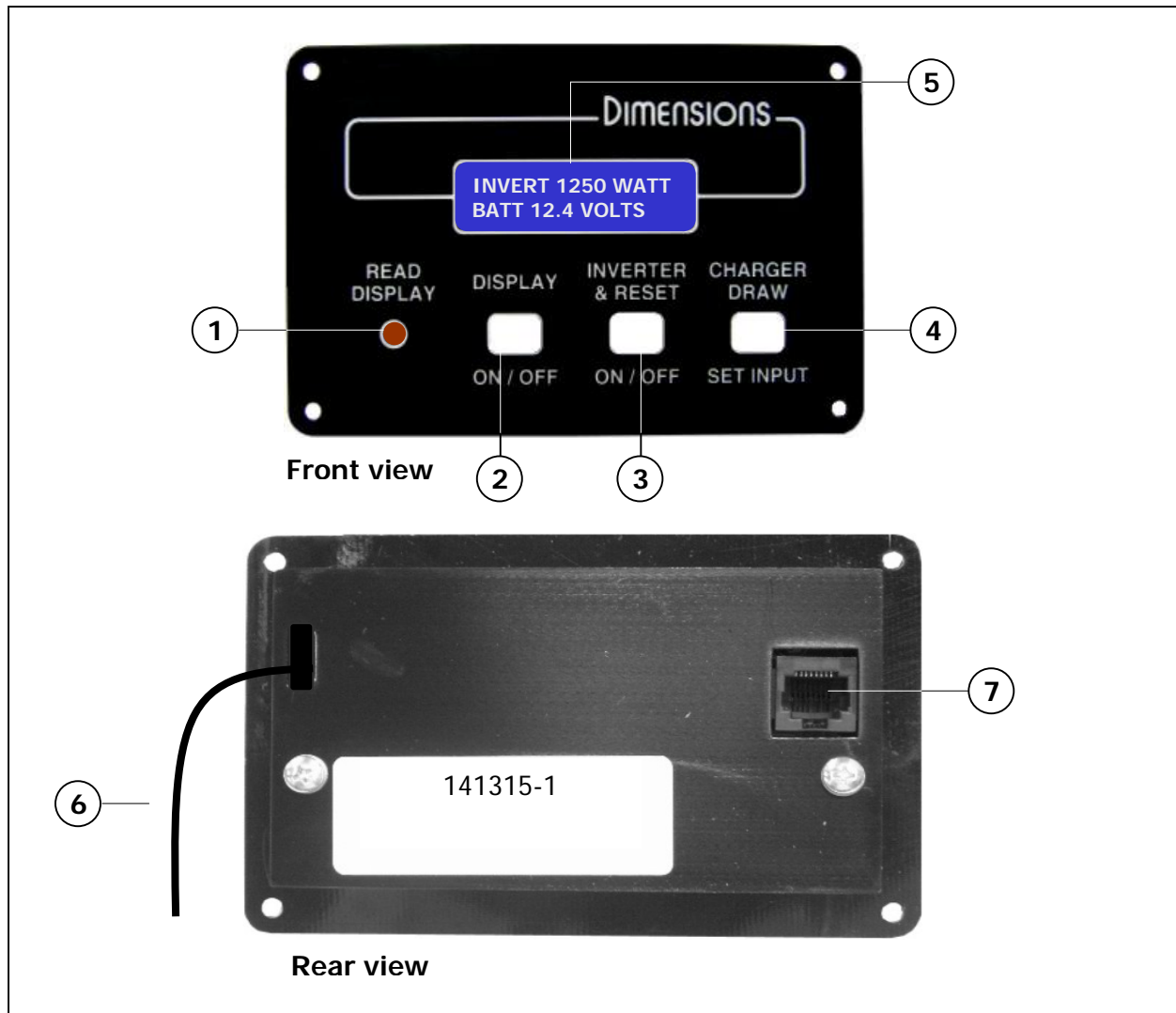

FIGURE 2: LCD Remote Control/Status Panel

- 1 **Read Display:** The red LED indicator will light when the SPS is in a warning condition.
- 2 **Display – On/Off:** Turns the LCD screen backlighting ON or OFF.
- 3 **Inverter & Reset – On/Off:** Turns the SPS ON or OFF and resets any error message.
- 4 **Charger draw – Set Input:** This button limits the input AC current for the battery charger.
- 5 **LCD Display:** Shows system status, battery voltage, and electrical current in both inverter and external power mode as well as shut down conditions.
- 6 **DC Master Disconnect switch control wire – “R1” Option:** Available with the LCD Remote Control/Status Panel – R1 assembly 141315-1. A 1-foot, red wire extends from the back of the panel and connects to the “DC master disconnect switch” which is found in most recreational vehicles.
- 7 **Flat cable connector jack:** Connects the 8-conductor flat gray signal cable coming from the SPS.







# Installation

## 5.1 Tools for Installation:

Tools required for installation: 3/8" Allen Wrench and socket wrench, connectors (butt type and insulated), drill, Crimpers (for insulated and non-insulated connectors), #2 Phillips screwdriver, wire cutters, wire strippers, cable ties, tape measure.

## 5.2 System Components:

Picture	Model and Description	Qty.
	12X16B3R4T, 12X20B3R4T, 12X25B3R4T, 12X30B3R4T, 12X36B3R4T	1
	LCD Remote Control/Status Panel assembly 141255-2 or 141315-1	1
	LCD Remote Control/Status Panel flat cable, 611446-XX; XX: Length of the cable in feet.	1
	Temp. Comp. Cable 611440-XX; XX: Length of the cable in feet.	1

## 5.3 Mounting the SPS:

	<i>The SPS mounting location should provide adequate ventilation and clearance to maintain room temperature during operation. At least 1/2 inch of clearance is required on all sides.</i>
---	--

- Locate a suitable, secure vertical or horizontal mounting surface as close to the batteries as possible without being in the same airtight compartment.
- If mounting the SPS on a vertical surface, it is recommended that the front panel be pointing down whenever possible.
- Locate the mounting holes on the chassis flanges and fasten them using 1/4 inch diameter screws to secure the inverter. See figure 3, page 10.

**5.3.1 Chassis Bonding Lug:** Connect the bonding lug located at the right side of the SPS chassis to the earth grounding system using an 8-gauge copper wire.

**5.3.2 Temperature Compensated Wire Sense:** Connect the two-conductor gray wire to the negative post of the battery bank. Failure to connect the remote temperature sense probe correctly will result in high output voltage that will cause severe damage and exploding batteries and fire.

**5.3.3 Connecting the LCD Remote Control/Status Panel:** Mount the panel last in a convenient, visible and accessible location. Connect the flat cable connector extending from the SPS module to the receptacle at the rear of the panel. 141315-1 assembly panels must connect the red wire extending from the back of the panel to the output of the DC master disconnect switch. See wiring connections on figure 6, page 14.

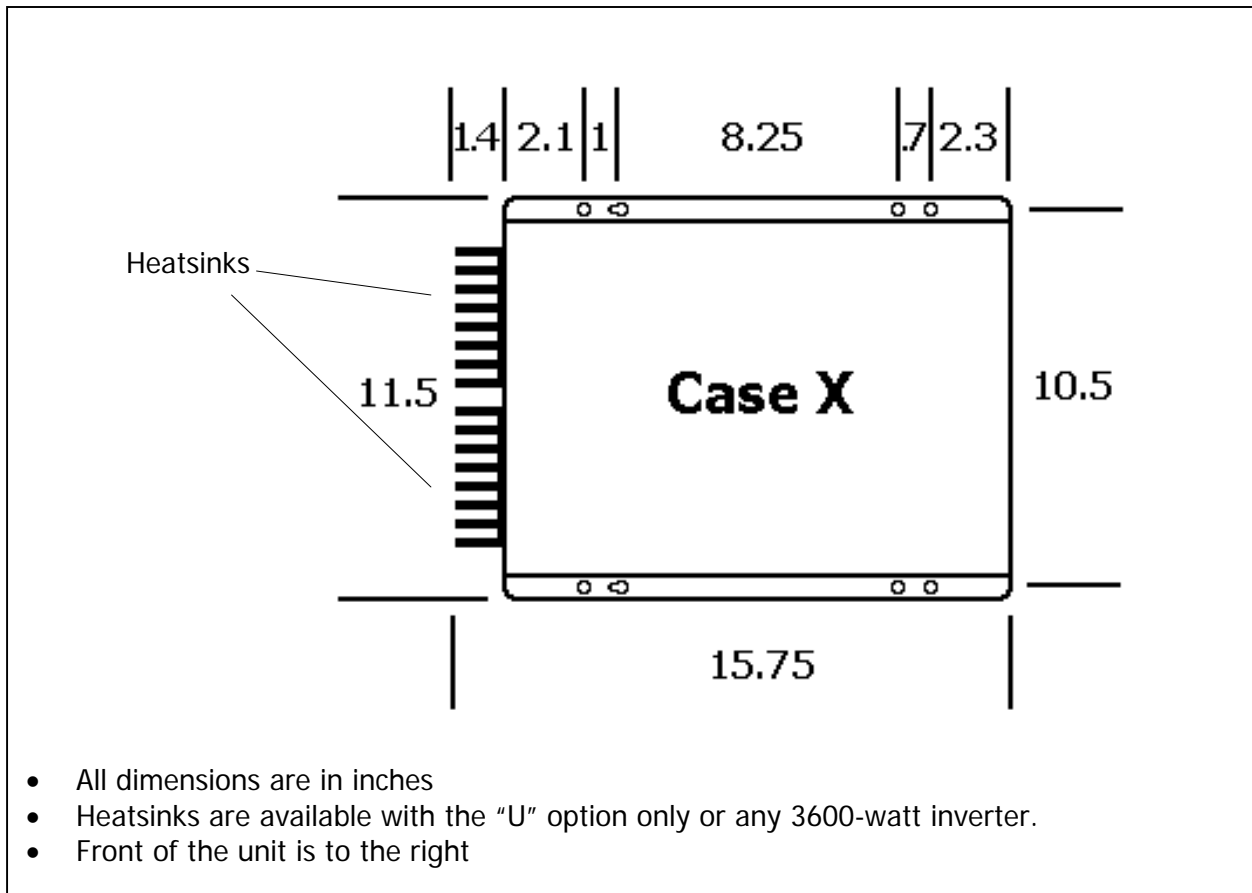

Figure 3: SPS footprint

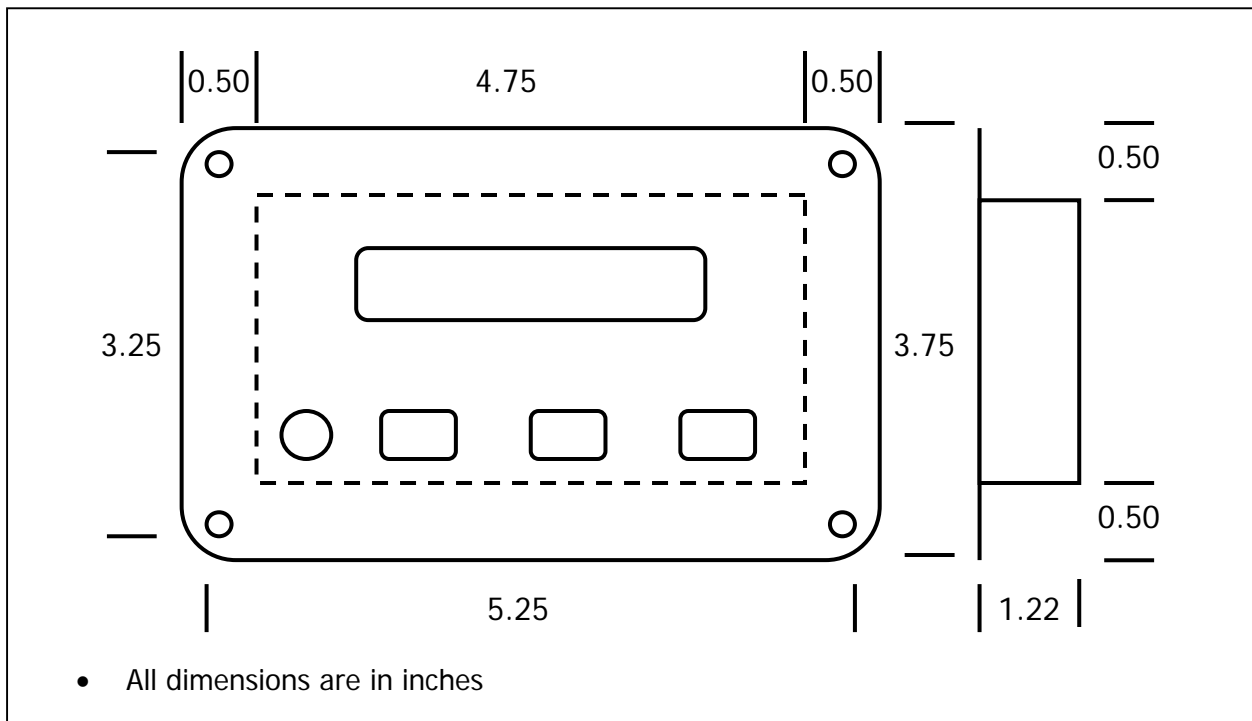

Figure 4: LCD Control panel footprint – Assemblies 141255-2 or 141315-1

# SPS Wiring:

## 6.1 DC Wiring:

- 1 It is recommended in all cases to use stranded copper wires.
- 2 Use SGX cross-linked polyurethane insulation type that complies with the high temperature insulation requirements (125°C.) of SAE J-1127 and vehicle manufacturer requirements.
- 3 Wire gauge recommendations are minimum. For higher temperature applications inside engine spaces or large motor loads and other applications with high surge currents use wire gauge 1 to 2 sizes larger than shown on table I.
- 4 Keep the wire runs between battery and SPS as short as possible.
- 5 Use Bussmann fuse type ANN-XXX and fuseblock # 3576 where XXX is the size of the fuse.

**6.1.1 Inverter Cable:** This is the cable that runs from the SPS to the batteries. Estimate the "inverter cable" length and locate your SPS model on table I, cross-reference the wire gauge and fuse size.

Table I: Wire and Fusing Guide for 12VDC systems at 5% Voltage Drop at Full Output

SPS Model	Full Load (Amps DC)	SPS to battery estimated cable length in feet		
		1' – 10'	11' – 15'	16' – 20'
12X16B3R4T	160	2-gauge, 250A fuse	1-gauge, 300A fuse	1/0-gauge, 350A fuse
12X20B3R4T	200	2-gauge, 250A fuse	1/0-gauge, 350A fuse	2/0-gauge, 400A fuse
12X25B3R4T	250	1/0-gauge, 350A fuse	2/0-gauge, 400A fuse	3/0-gauge, 500A fuse
12X30B3R4T	300	2/0-gauge, 400A fuse	3/0-gauge, 500A fuse	4/0-gauge, 600A fuse
12X36B3R4T	360	4/0-gauge, 600A fuse	4/0-gauge, 600A fuse	Not Recommended

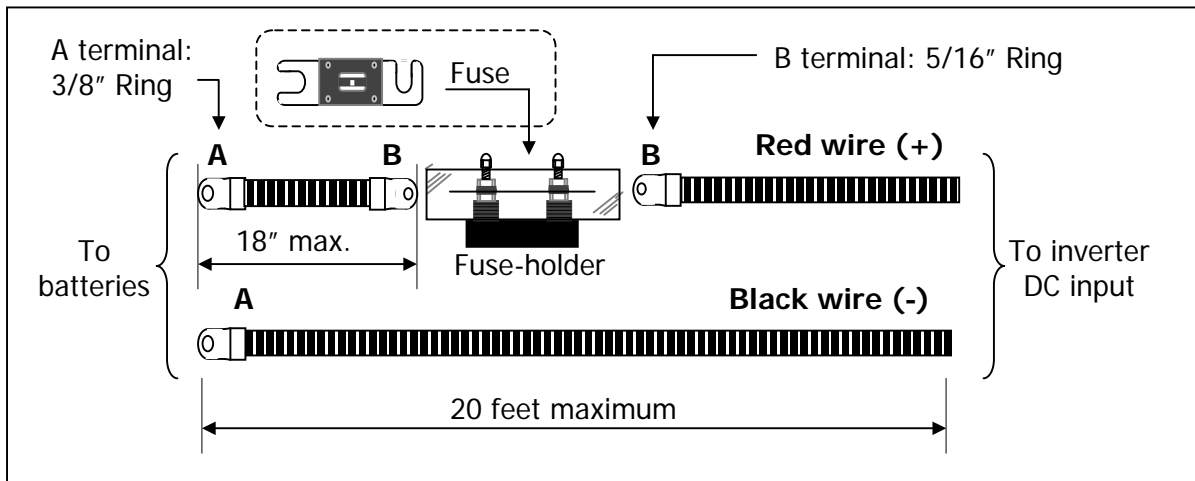

Figure 5: Inverter cable assembly

**6.1.2 Charge Cable:** This is the cable that runs from the batteries to vehicle alternator or OEM engine battery. Use 2-gauge cables and 250A fuse for small OEM alternators and 1/0-gauge and 350A for heavy-duty alternators.

### 6.1.3 Connecting the DC cables



*Damage to the SPS not covered under warranty will occur if correct polarity is not observed when installing the DC input cables.*

- Refer to Figure 6: DC wiring diagram.
- Open the SPS field-wiring compartment to access the DC input lugs.
- Unscrew the DC input lug POS (+) and NEG (-) 3/8" Allen screws.
- Remove the fuse from the fuseholder for cable installation.
- Remove 1 inch of insulation from the un-terminated ends of the red and black cables.
- Insert the stripped end of the red wire into the DC input lug labeled POS (+) and the stripped end of the black wire into the DC input lug labeled NEG (-). Tighten the 3/8" Allen screws to 23 Ft. Lbs.
- Tighten the cover DC cable strain relief screws to 1 Ft. Lb.
- Connect the end of the short red cable to a POS (+) battery post.
- Connect the terminated end of the black cable (neg. return cable) directly to a battery NEG (-) post (DO NOT connect to the chassis).
- Install the in-line fuse in the fuseholder that is within 18" of the positive post of the battery bank (a one-time spark will occur when this final DC connection is made). To determine the fuse size, refer to section 6.1.1.

### 6.1.3 Deep Cycle Batteries:



*Do not use vehicle-starting batteries; deep discharge cycles typical with inverter applications can shorten the life of this type of batteries.*

- Install at least one auxiliary deep cycle battery to feed the SPS directly.
- Depending on the application running time more batteries could be added if necessary. The vehicle alternator will recharge the batteries.
- It is recommended to mount the battery bank close to the SPS.
- The maximum recommended distance between the SPS and the battery bank is 20 feet.
- The battery compartment must be vapor-tight to the interior of the vehicle and vented directly to the exterior.
- Install several vent-plugs within one inch of the top of the battery compartment to allow for ventilation. Install a ventilation assembly as needed.
- Allow space around the battery and especially above the battery for inspection, and maintenance purposes.
- The battery should not be able to move more than 1 inch in any direction.



*Install the LCD Remote Control/Status Panel last, after the batteries, DC wires and AC wires been installed.*

## 6.2 AC Wiring:

Remove the SPS field-wiring compartment cover plate to access the 120VAC, 60Hz input and output hardwire leads and follow the color code connections: Hot - Black wire, Neutral - White wire, Ground - Green wire.

**6.2.1 AC Output:** The 120 VAC, 60 Hz current produced by the SPS is presented behind the wiring compartment panel with direct hardwire leads.

- The hardwire leads are not GFCI protected and must require the installation of remote GFCI outlets. The GFCI outlets model recommended is Hubbell # GFR 5352XX (20A) or GFR 5252XX (15A).



*Do not connect another source of AC power directly to the output of the SPS. This will result in damage to the SPS that is not covered under warranty.*

**6.2.2 AC Input:** The transfer switch "T" has AC input hardwire leads which can be connected to an external power line 120VAC, 60Hz outlet. The cable clamp strain relief should be used to secure the field wires. The input circuit should have a maximum 30 amps circuit protection from the distribution panel. If the input cable to the unit is 14-gauge, then a 15 amps circuit protection is required.



*Install the LCD Remote Control/Status Panel last, after the batteries, DC wires and AC wires been installed.*

### 6.3 DC Wiring Diagram

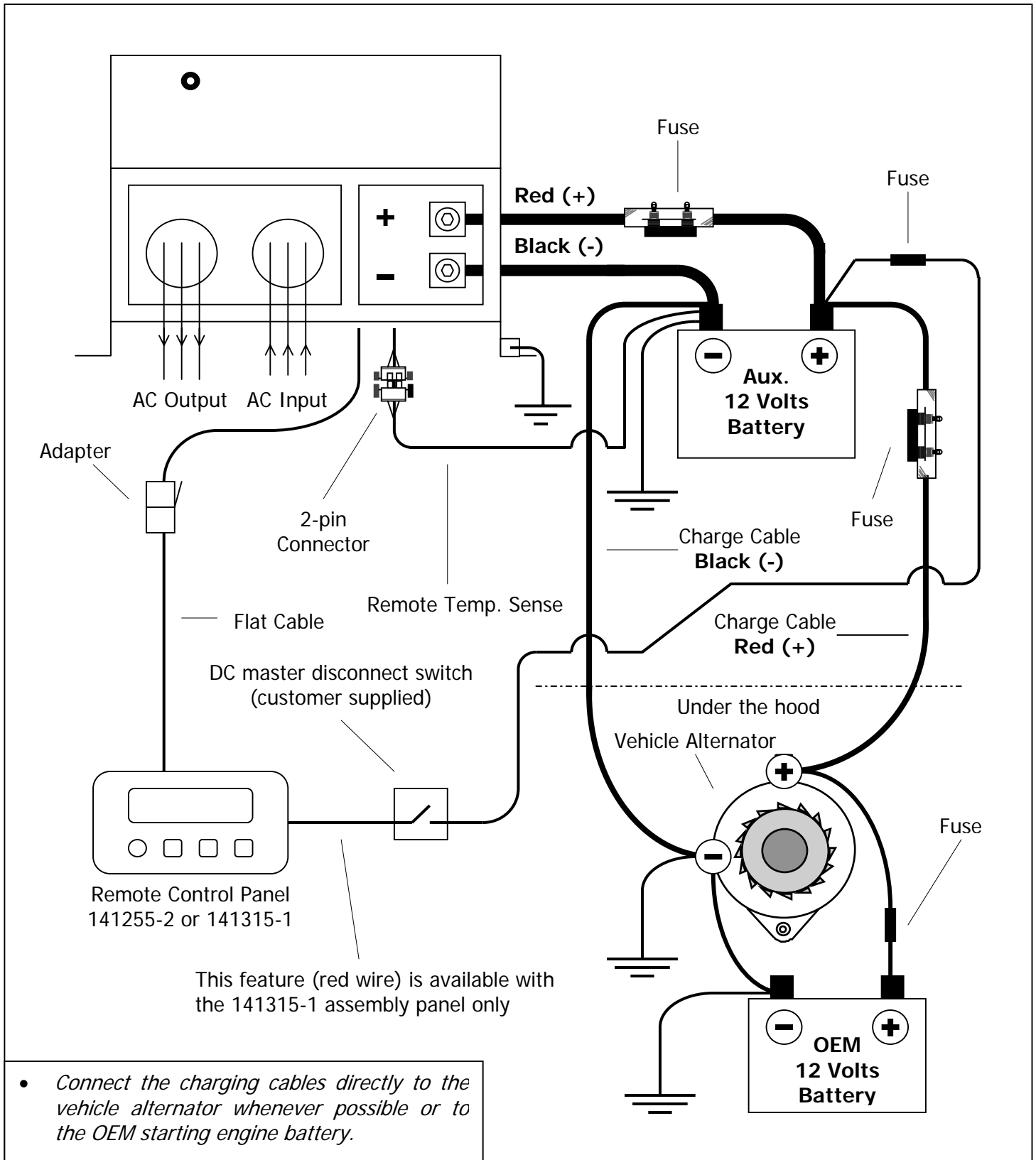

Figure 6: DC wiring diagram

## 6.4 AC Wiring Diagram

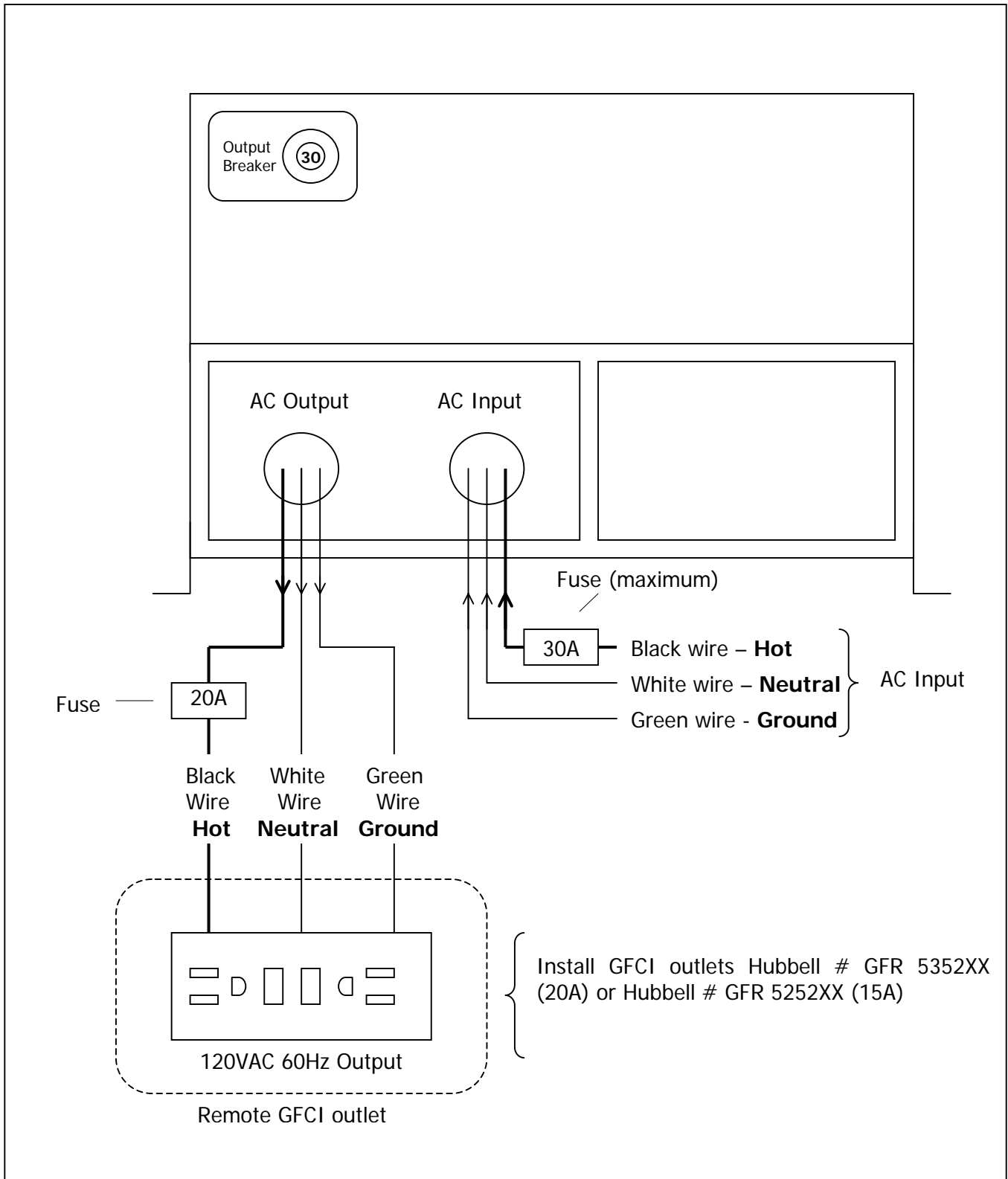



Figure 7: AC wiring diagram

# Operation and Troubleshooting

## 7.1 Operation

	<i>The battery voltage must be higher than 9 volts for the SPS to operate.</i>
---	--

**7.1.1 Setting the Battery Size and Type:** The battery selector switch located at the right side of the chassis must be set according to the type and size of the battery bank the SPS is connected to as shown in table II below.

TABLE II: BATTERY SELECTOR SWITCH POSITION

BATTERY BANK SIZE (Amp-Hour)	DEEP CYCLE BATTERY TYPE	
	SEALED LEAD ACID	WET LEAD ACID
More than 400	A	C
Less than 400	B	D

TABLE III: BATTERY CHARGER VOLTAGES

BATTERY TEMPERATURE		WET CELL BATTERIES			SEALED BATERIES		
		ACCEPT (Volts)	FLOAT (Volts)	CONDITIONING (Volts)	ACCEPT (Volts)	FLOAT (Volts)	CONDITIONING (Volts)
°F	°C	14.6	13.2	14.9 to 15 max.	14.2	13.2	14.4 to 15 max.
78	25						

TABLE IV: BATTERY CHARGER TIME PERIODS

BATTERY BANK SIZE (Amp-Hour)	WET CELL TYPE BATTERIES			SEALED TYPE BATTERIES		
	BULK (max.)	ACCEPT (max.)	CONDITIONING (max.)	BULK (max.)	ACCEPT (max.)	CONDITIONING (max.)
Less than 400	6-hrs.	2-hrs.	3-hrs.	6-hrs.	2-hrs.	3-hrs.
Greater than 400	8-hrs.	3-hrs.	6-hrs.	8-hrs.	3-hrs.	4-hrs.

	<i>If the bulk mode times-out the charging process will go to the float mode immediately bypassing the acceptance mode.</i>
---	---

**7.1.2 Turning the SPS ON:** After correct installation, the built-in transfer relay automatically switches the SPS to “external power” mode activating the battery charger any time a proper external AC voltage source is present. Setting the charger current draw to zero with the LCD Remote Control/Status Panel can turn off the battery charger. See figure 2, item (4) page 8.

The “inverter mode” can only be activated when there is no proper voltage external AC power source. The inverter is turned ON or OFF by the LCD Remote Control/Status Panel. See figure 2, item (3) page 8. The inverter can be left ON and the SPS will automatically cycle back and forth between the battery charger and inverter. However, there is a one to two amps draw on the batteries when the inverter is ON and there are no AC loads which could discharge the battery(s).



Pressing any button enables the panel. This first button activation shows the status. To change, press the button again.

**7.1.3 Battery Charger Draw - Set Input:** The SPS automatically limits the battery charger AC current draw to a maximum of 25 Amps and the SPS also has the automatic power share feature (see section 2.3.3 page 12). The user may want to further limit the charger's maximum AC current draw because of a limited capacity "shore" power source (ie: 15 Amps rather than 30 or 50 Amps).

Decrease the input AC charge current limit in increments of 5 Amps by pressing the "CHARGER DRAW – SET INPUT" button on the Inverter/Charger Control Panel (see figure 2, item 4, page 7).

**7.1.4 LCD Remote Control/Status Panel Display Messages:**

MESSAGE	MESSAGE EXPLANATION
a) <b>INVERTER xxxx WATT BATT xx.x VOLTS</b>	This indicates that the SPS is in "inverter mode". The panel displays the wattage of the load and the voltage of the batteries. The "inverter mode" will activate only if there is no external AC power connected to the SPS.
b) <b>CHGR-OFF NO INPT INVERTER-OFF</b>	This indicates that the battery charger is OFF because there is no external AC power connected to the SPS. The inverter is also turned OFF.
c) <b>CHGR-OFF 0 AMP LIMIT SET</b>	When external AC power is connected to the SPS the three-stage battery charger may be activated. This indicates that the charge current limit has been set to 0 amps (see section 7.1.3 on this page). The battery charger is not active.
d) <b>CHGR-BULK MODE xx.x VOLT, xxx AMP</b>	This indicates that the three-stage charger is in the bulk mode. The bulk mode is the first stage of the battery charging process. The display also indicates the battery voltage and the amount of DC charge current flowing into the batteries. See tables II & III on page 15 for more information.
e) <b>CHGR-ACCEPT MODE xx.x VOLT, xxx AMP</b>	This indicates that the charger is in the acceptance mode, the second stage of the battery charging process. The display also indicates the battery voltage and the amount of DC charge current flowing into the batteries. See tables II & III on page 15 for more information.
f) <b>CHGR-FLOAT MODE xx.x VOLT, xxx AMP</b>	This indicates that the charger is in the float mode, the third stage of the battery charging process. The display also indicates the battery voltage and the amount of DC charge current flowing into the batteries. See tables II & III on page 15 for more information.

<p>g) <b>CHGR- COND MODE xx.x VOLT, xxx AMP</b></p>	<p>This indicates that the charger is in the conditioning mode. Battery conditioning is automatically performed every 10<sup>th</sup> complete charge cycles. The display also indicates the battery voltage and the amount of DC charge current flowing into the batteries. See tables II &amp; III on page 15 for more information.</p>
<p>h) <b>INVERTER-OFF PUSH FOR STANDBY</b></p>	<p>This message is displayed when you press the "<i>Inverter &amp; Reset – On/Off</i>" button while the SPS is in the external power mode and the battery charger is activated. It indicates that the inverter is OFF and will <u>not</u> automatically turn ON when external power is removed. Pressing the button again will result in message (j) below. This message will be displayed for ten seconds.</p>
<p>i) <b>INVERTER – OFF PUSH FOR ON</b></p>	<p>This message is displayed when you press the "<i>Inverter &amp; Reset – On/Off</i>" button while the inverter is OFF and there is no external power connected to the SPS. Pressing this button again will turn the inverter ON and message (a) will appear.</p>
<p>j) <b>INVERT-STANDBY OVERRIDE BY CHGR</b></p>	<p>This message is displayed when you press the "<i>Inverter &amp; Reset – On/Off</i>" button while the SPS is in the external power mode and the battery charger is activated. It indicates that the inverter will automatically turn ON when the external power is removed. Pressing this button again will result in message (h) above. This message will be displayed for ten seconds.</p>
<p>k) <b>CHGR POWER DRAW LIMIT xx AMP AC</b></p>	<p>This message is displayed when you press the "<i>Charger Draw – Set Input</i>" button. It indicates the battery charger input current limit setting. Pressing this button again will decrease the current limit. This is explained in more detail in section 7.1.3, page 16. This message will be displayed for ten seconds.</p>

## 7.2 Troubleshooting

Call or e-mail Customer Service Department for free consultation during business hours (central time zone) at: 1-800-553-6418 or 1-651-653-7000; fax: 1-651-653-7600; e-mail: [sales@dimensionsunlimited.com](mailto:sales@dimensionsunlimited.com)

	<i>A TRUE RMS voltmeter is required for accurate AC output voltage readings on quasi-sine inverters. Other voltmeters that use averaging circuitry will give a false reading.</i>
---	---

- The LCD Remote Control/Status Panel “Read Panel” Red LED warning indicator will light to indicate a problem either with the inverter or battery charger. Press the “Panel – On/Off” button to turn the display ON.
- A problem with the transfer relay is indicated when it fails to switch between battery power “inverter mode” and “external power mode” or when appliances do not operate when the inverter is in “external power mode”.
- Unplug all loads and connect a 100-watt light bulb to the inverter output. Observe the LCD Remote Control/Status Panel then check the troubleshooting table.

### 7.2.1 Troubleshooting Chart

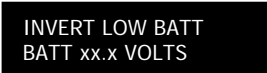
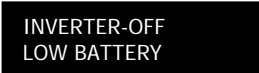
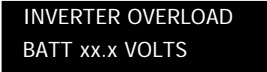
	MESSAGE	PROBLEM	POSSIBLE CAUSE
1		The SPS is not connected to the batteries or the battery voltage is below 9 volts DC.	Check the in-line fuses for continuity. Make sure the DC wires are clean and tight. Check the DC voltage at the inverter DC input.
2		Indicates immediately that the SPS is operating in a low battery voltage condition.	Fault in the battery wiring, battery capacity and voltage or the in-line fuse. This message will automatically clear or the screen will go to message 3.
3		Indicates that the inverter has shut off due to a low battery condition. Press the “ <i>inverter &amp; reset – On/Off</i> ” button three times to turn the inverter back ON.	The same screen message coming on again indicates a fault in the battery wiring, battery capacity and voltage or the in-line fuse. If the condition persists, call Dimensions.
4		Indicates immediately that the SPS is operating in an overload condition.	SPS output wiring is shorting or loads that exceed rating. This message will automatically clear or the screen will go to message 5.

5	INVERTER - OFF OVERLOAD	Indicates that the SPS has shut off due to an overload condition.	Remove the short circuit or excessive load from the output, and then press the <i>"inverter &amp; Reset On/Off"</i> button three times to turn the inverter back ON. If the condition persists, call Dimensions.
6	INVERTER - OFF HIGH TEMP	Indicates that the inverter has shut off due to high internal temperature. The unit will automatically turn back on when it has cooled to 40°C (104°F)	Verify that the SPS is not in a closed compartment and that the fan is not blocked. High ambient temperatures combined with a poor ventilation condition may also contribute to the shut down of the SPS.
7	INVERTER - OFF HIGH BATTERY	Indicates that the inverter has shut off due to high battery voltage. The unit will automatically turn back on when the condition is removed.	Check battery wiring or remove other source of battery charging, such as the vehicle alternator.
8	CHARGER - OFF HIGH TEMP	Indicates that the charger has shut off due to high internal temperature. The unit will automatically turn back on when it has cooled to 40°C (104°F)	Shorted or defective battery. Make sure that the DC cable connections are tight and clean and not shorted, and that the proper wire gauge is used.
9	CHARGER - OFF BATT HIGH TEMP	Indicates that the charger has shut off due to high battery temperature 47°C – 50°C (117°F - 122°F).	Battery compartment is too hot and needs to cool down. The charger will automatically turn back on when it has cooled down to 40°C (104°F)
10	CHARGER - OFF CHECK BATT PROBE	Indicates that the charger has shut off due to short or open temperature compensating sensor cable.	Temperature compensation sensor cable needs to be replaced.
11	CHGR-ON LO-VOLT CHECK BATTERIES	Indicates that the charger is operating in a low DC output voltage condition.	Shorted or defective battery. Make sure that the DC cable connections are tight and clean and not shorted, and that the proper wire gauge is used.
12	CHGR-OFF HI-VOLT RESET OR SERVICE	Indicates that the charger is operating in a high DC output voltage condition.	There is another source of battery charging or there is a defective battery charger. Disconnect and reconnect the external AC power to restart the battery charger. If condition persists, call Dimensions.

**7.2.2 System Flow Chart**

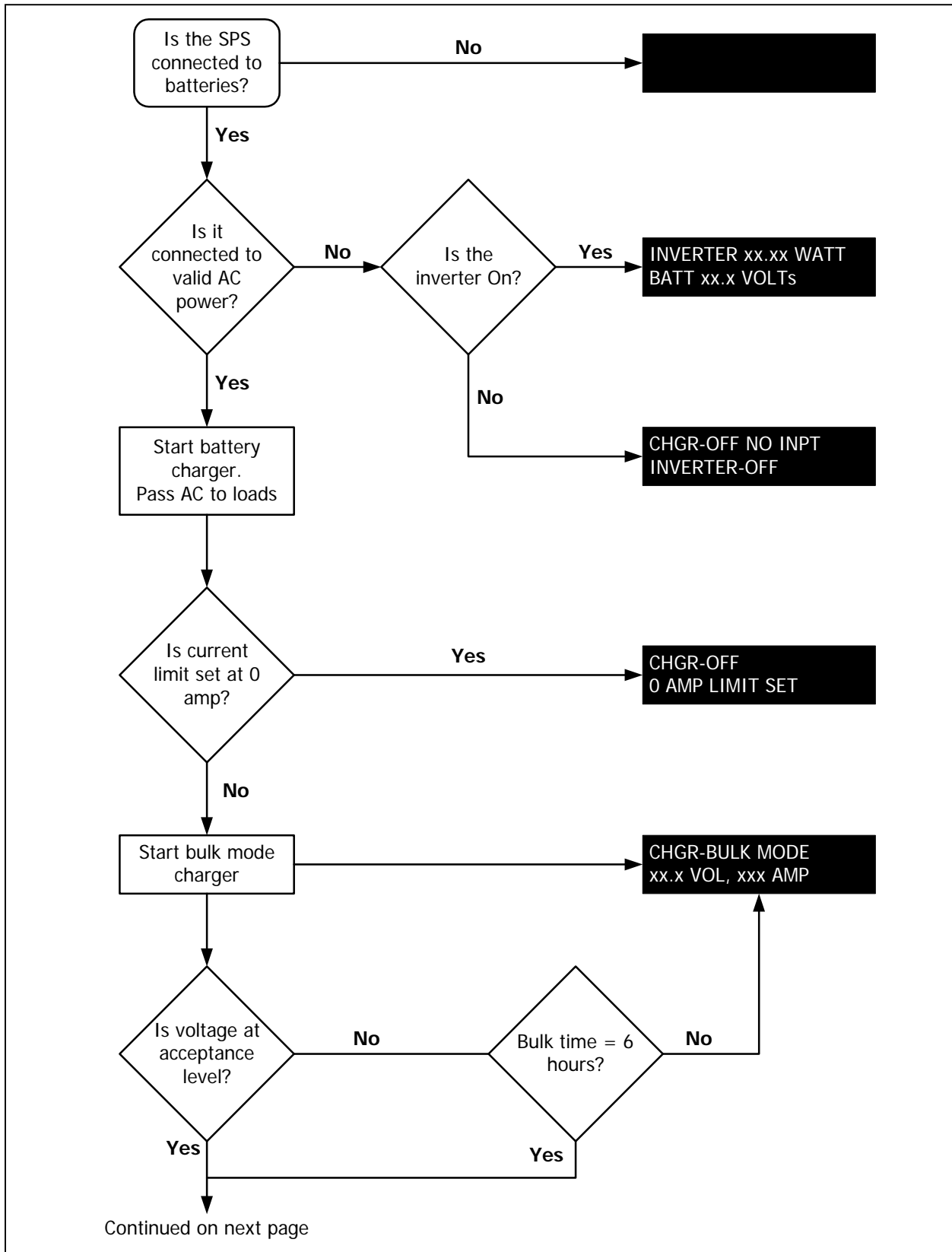

FIGURE 8: System flow chart

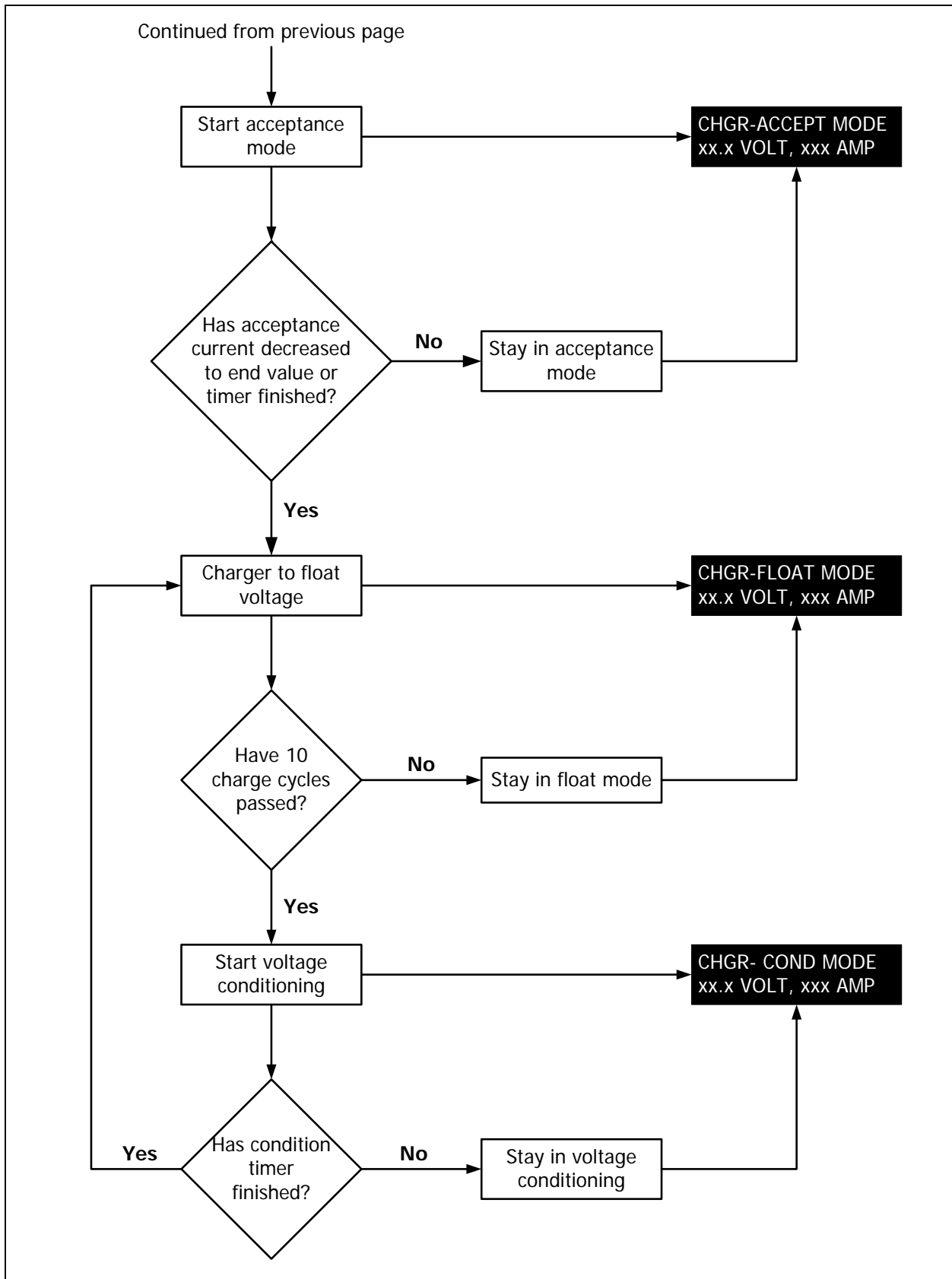

FIGURE 9: System flow chart (continued from page 20)

# Warranty

**SHIPPING TERMS:** F.O.B. St. Paul Minnesota. Freight prepaid and billed, subject to prior credit approval.

**MINIMUM ORDER:** \$50.00 Net Price

**LOSS OR DAMAGE:** Loss or damage in transit is the responsibility of the carrier. Any claim should be filed with the delivering transport company. Invoice, Bill of Lading and Delivery receipt with damage noted therein must accompany any claims for freight damage. Claims for shortage and lost shipments must be made in writing to Dimensions Unlimited, St. Paul, MN within 10 days of date of shipment. Claims not reported within this time frame will not be honored.

**PRICES:** Prices are subject to change without notice. All orders are subject to acceptance at the factory. We reserve the right to invoice prices in effect at time of shipment.

**TERMS:** Net 30 days with approved credit, credit card or C.O.D.

## **RETURN GOODS POLICY**

- No returned materials will be accepted without an accompanying Returned Materials Authorization Number (RMA) from factory.
- Credit will be issued for returned goods to the original purchaser within 60 days of purchase, provided the inverter is returned to Dimensions unused and not mounted. The amount of credit will be issued at Dimensions discretion based on the condition of the product.
- Customer must be in good standing with Dimensions Unlimited.
- Inverters that are discontinued, high-voltage (over 24vdc), special-order or used are excluded and will not be eligible for credit. Non-inverter items such as cable assemblies, fuses and fuse holders, will not be eligible for credit.
- Support components supplied by Dimensions vendors will be covered under that manufacturer's credit return policy.
- Customer pays return freight.

## **PLEASE SHIP FREIGHT PREPAID AUTHORIZED RETURNS TO:**

Dimensions Unlimited, Inc. / 4467 White Bear Parkway / St. Paul, MN 55110

**LIMITED WARRANTY:** Dimensions Unlimited warrants to the original purchaser for use that the goods or any component thereof manufactured by Dimensions Unlimited will be free from defects in workmanship from the date of purchase for the period listed on the product label, provided such goods are installed, maintained and used in accordance with Dimensions Unlimited and the original manufacturer's written instructions.

Components not manufactured by Dimensions Unlimited, but used within the assembly provided by Dimensions, are subject to the warranty period as specified by the individual manufacturer of said component, provided such goods are installed, maintained and used in accordance with Dimensions Unlimited and the manufacturer's written instructions.

Dimensions Unlimited sole liability and the Purchaser's sole remedy for a failure of goods under this limited warranty and for any and all claims arising out of the purchase and use of the goods, shall be limited to the repair or replacement of the goods that do not conform to this warranty. The return of the purchase price in cash is at the sole discretion of Dimensions.

To obtain repair or replacement service under the limited warranty, the purchaser must contact the factory for a Return Material Authorization (RMA). Once obtained, send the Return Material Authorization Number along with the defective part or goods to: Dimensions Unlimited Inc., 4467 White Bear Parkway, St. Paul, MN 55110, freight prepaid.

THERE ARE NO EXPRESS WARRANTIES COVERING THESE GOODS OTHER THAN AS SET FORTH ABOVE. THE IMPLIED WARRANTIES OF MERCHANTABILITY AND FITNESS FOR PARTICULAR PURPOSE ARE LIMITED IN DURATION TO ONE YEAR FROM DATE OF PURCHASE.

DIMENSIONS UNLIMITED ASSUMES NO LIABILITY IN CONNECTION WITH THE INSTALLATION OR USE OF THE PRODUCT, EXCEPT AS STATED IN THIS LIMITED WARRANTY. DIMENSIONS UNLIMITED WILL IN NO EVENT BE LIABLE FOR INCIDENTAL OR CONSEQUENTIAL DAMAGES.

**WARNING: LIMITATIONS ON USE:** Dimensions Unlimited products are not intended for use in connection with Life Support Systems and for Avionic use. Dimensions Unlimited makes no warranty or representation in connection with their products for such uses.